

INTERLOCK AUTOMATIC THREAD  
TRIMMER DEVICE SERIES

# CONTENTS ◀ 目录

**Yamato**

VC2700-AUT/EUT	2
VG2700-AUT/EUT	3
VE2700-AUT/EUT	4
VF2500-AUT/EUT	5
VT1500-AUT/EUT	6
VT1513-AUT/EUT	7
FD62四针六线	8

**JUKI**

MF7823-AUT/EUT	10
MF7923-AUT/EUT	11
MF7223-AUT/EUT	12
MF7723-AUT/EUT	13
1900A套结机	14

**brother**

430D套结机	16
---------	----

**PEGASUS**

W600-AUT/EUT	18
W1600-AUT/EUT	19
W3600-AUT/EUT	20
W264-AUT/EUT	21
W500-AUT/EUT	22
FS701P四针六线	23

**SIRUBA**

CO07K-AUT/EUT	25
S007K-AUT/EUT	26
F007K-AUT/EUT	27
VC008多针机	28

**KANSAI  
SPECIAL**

RX9803-AUT/EUT	30
KS44系列多针机	31

**SHING RAY**

FW787-AUT/EUT	33
FW740多针机	34

**Kingtex**

CT9000-AUT/EUT	36
----------------	----

**For** ***Lyamato*** **Series**



# 大和VC2700-AUT/EUT

YAMATO VC2700-AUT/EUT



刀盘  
Knife Carrier



气动下剪线组件  
Air Under Trimmer Drive



气动抬压脚组件  
Air Presser Foot Lifter



松线组件  
Tension Disc Separator



电磁阀组件  
Electromagnetic valve assembly



调压阀组件  
Pressure valve assembly

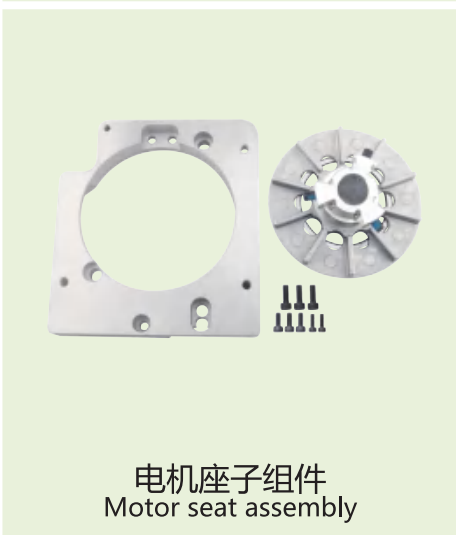

电机座子组件  
Motor seat assembly



下剪线组件  
Under Trimmer Drive



抬压脚组件  
Presser Foot Lifter

# 大和VG2700-AUT/EUT



## YAMATO VG2700-AUT/EUT



刀盘  
Knife Carrier



气动下剪线组件  
Air Under Trimmer Drive



气动抬压脚组件  
Air Presser Foot Lifter



电磁阀组件  
Electromagnetic valve assembly



松线组件  
Tension Disc Separator



调压阀组件  
Pressure valve assembly



松线传动组件  
Transmission Unit of Tension Disc Separator



下剪线组件  
Under Trimmer Drive



抬压脚组件  
Presser Foot Lifter

# 大和VE2700-AUT/EUT YAMATO VE2700-AUT/EUT

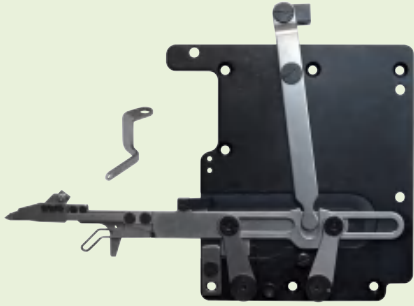

刀盘  
Knife Carrier

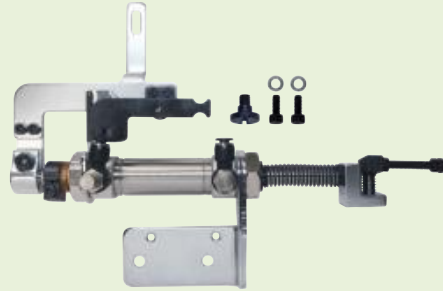

气动下剪线组件  
Air Under Trimmer Drive



气动抬压脚组件  
Air Presser Foot Lifter



电磁阀组件  
Electromagnetic valve assembly

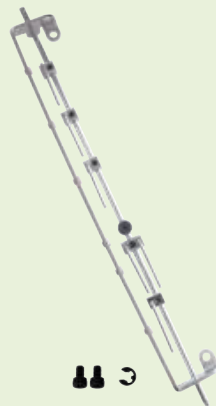

松线组件  
Tension Disc Separator



调压阀组件  
Pressure valve assembly



松线传动组件  
Transmission Unit of Tension Disc Separator



下剪线组件  
Under Trimmer Drive



抬压脚组件  
Presser Foot Lifter

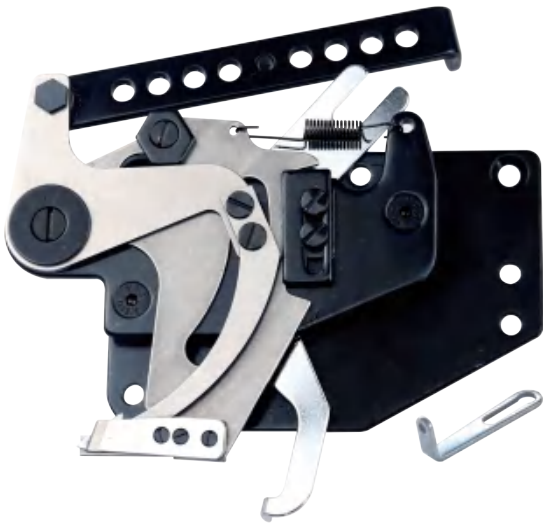

大和VF2500-AUT/EUT  
YAMATO VF2500-AUT/EUT

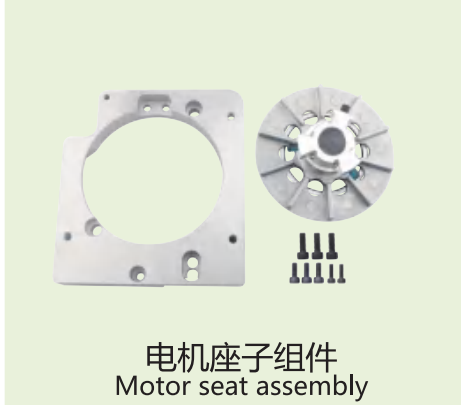

# 大和VT1500-AUT/EUT

## YAMATO VT1500-AUT/EUT

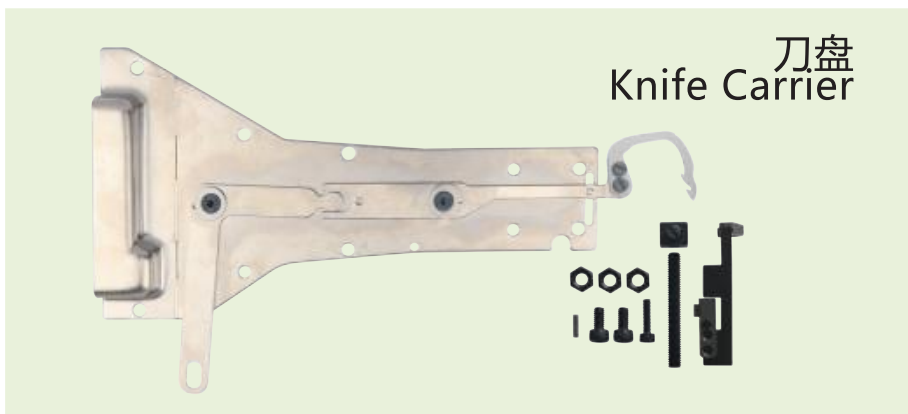

刀盘  
Knife Carrier



盖板  
Cover



气动下剪线组件  
Air Under Trimmer Drive



气动抬压脚组件  
Air Presser Foot Lifter



下巴套组件  
Chin sleeve assembly



松线组件  
Tension Disc Separator



松线传动组件  
Transmission Unit of Tension Disc Separator



调压阀组件  
Pressure valve assembly



电机座子组件  
Motor seat assembly



下剪线组件  
Under Trimmer Drive



抬压脚组件  
Presser Foot Lifter

# 大和VT1513-AUT/EUT

YAMATO VT1513-AUT/EUT

刀盘  
Knife Carrier



盖板  
Cover



气动下剪线组件  
Air Under Trimmer Drive



气动抬压脚组件  
Air Presser Foot Lifter



松线组件  
Tension Disc Separator

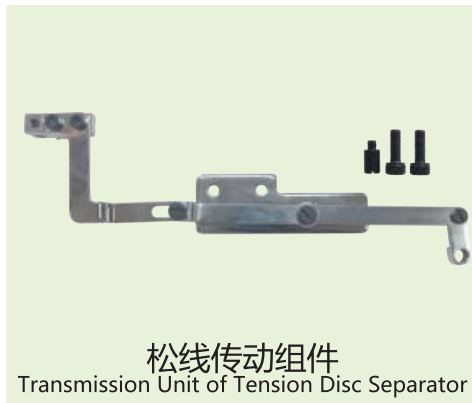

松线传动组件  
Transmission Unit of Tension Disc Separator



调压阀组件  
Pressure valve assembly

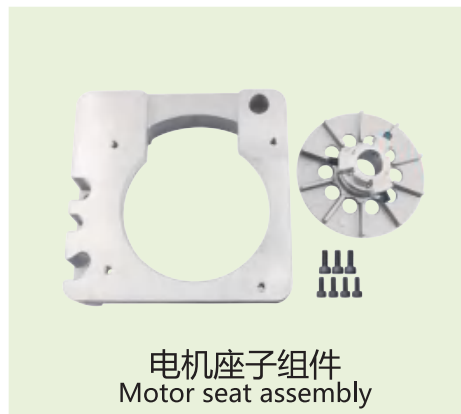

电机座子组件  
Motor seat assembly



下剪线组件  
Under Trimmer Drive



抬压脚组件  
Presser Foot Lifter

# 大和FD62四针六线

## YAMATO FD62 FLATSEAMER

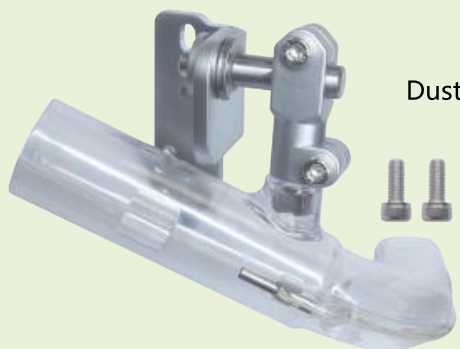

吸布屑管  
Dust suction tube

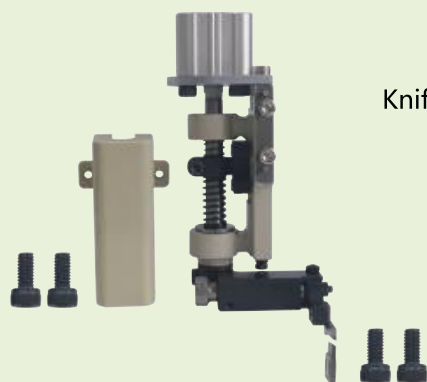

斩刀  
Knife assembly



面盖  
Panel cover



吸线头管  
Suction tube



电磁阀组件  
Electromagnetic valve assembly



控制器  
Controller



手控开关  
Manual switch



光电传感器  
Photoelectric sensor



吹风集成装置  
Blowing integrated device



调压阀组件  
Pressure valve assembly



膝控开关  
Knee switch



零部件  
Accessories

**For** **WUKI** **Series**

# 重机7823-AUT/EUT

## JUKI 7823-AUT/EUT



刀盘  
Knife Carrier



气动下剪线组件  
Air Under Trimmer Drive



气动抬压脚组件  
Air Presser Foot Lifter



松线组件  
Tension Disc Separator



松线传动组件  
Transmission Unit of Tension Disc Separator



调压阀组件  
Pressure valve assembly



电机座子组件  
Motor seat assembly

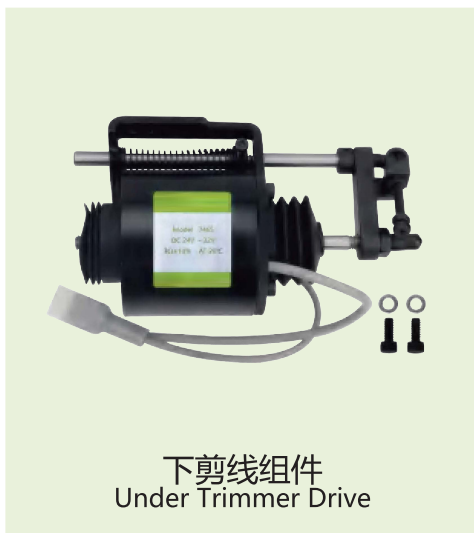

下剪线组件  
Under Trimmer Drive



抬压脚组件  
Presser Foot Lifter



# 重机7923-AUT/EUT

JUKI 7923-AUT/EUT

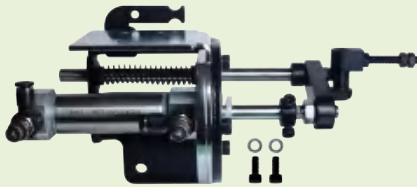

气动下剪线组件  
Air Under Trimmer Drive



气动抬压脚组件  
Air Presser Foot Lifter



电磁阀组件  
Electromagnetic valve assembly



松线组件  
Tension Disc Separator



松线传动组件  
Transmission Unit of Tension Disc Separator



调压阀组件  
Pressure valve assembly



电机座子组件  
Motor seat assembly



下剪线组件  
Under Trimmer Drive



抬压脚组件  
Presser Foot Lifter



# 重机 MF7223-AUT/EUT

## JUKI MF7223-AUT/EUT



刀盘  
Knife Carrier



气动下剪线组件  
Air Under Trimmer Drive



气动抬压脚组件  
Air Presser Foot Lifter



松线组件  
Tension Disc Separator



松线传动组件  
Transmission Unit of Tension Disc Separator



调压阀组件  
Pressure valve assembly



电机座子组件  
Motor seat assembly



下剪线组件  
Under Trimmer Drive



抬压脚组件  
Presser Foot Lifter

# 重机 MF7723-AUT/EUT

## JUKI MF7723-AUT/EUT

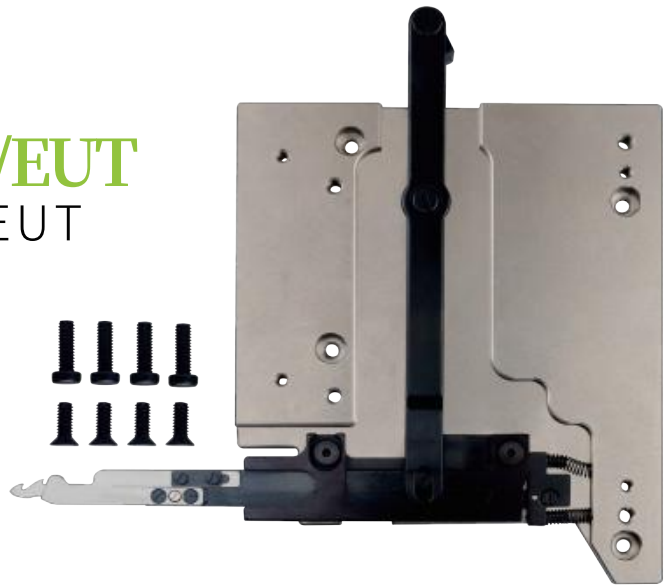

盖板  
Cover

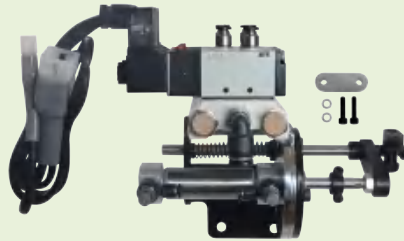

气动下剪线组件  
Air Under Trimmer Drive



气动抬压脚组件  
Air Presser Foot Lifter

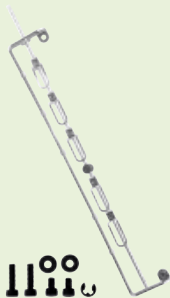

松线组件  
Tension Disc Separator



松线传动组件  
Transmission Unit of Tension Disc Separator



调压阀组件  
Pressure valve assembly

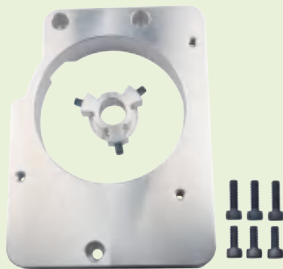

电机座子组件  
Motor seat assembly



下剪线组件  
Under Trimmer Drive



抬压脚组件  
Presser Foot Lifter

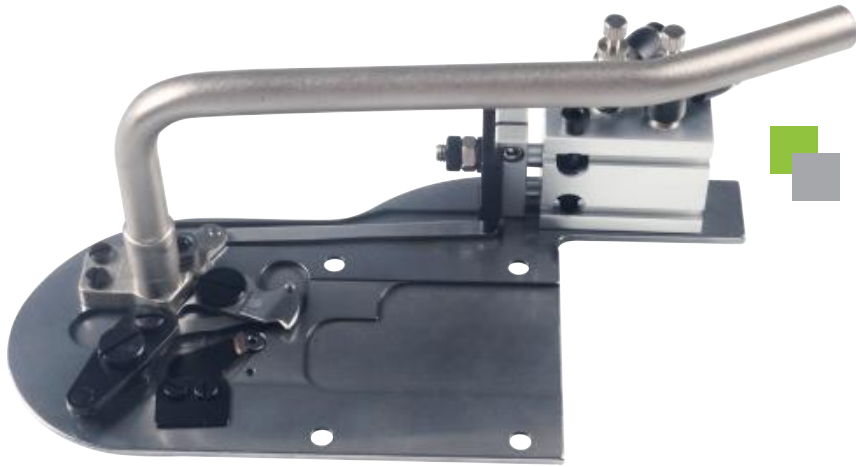

# 重机 1900A 套结机

## JUKI 1900A Bartacking Sewing Machine



**For**  
**brother**  
**Series**

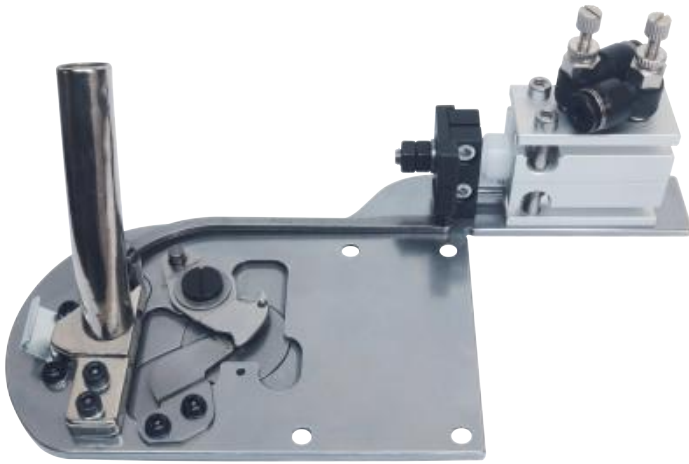

兄弟 430D 套结机  
 Brother 430D  
 Bartacking Sewing Machine  
 >>>

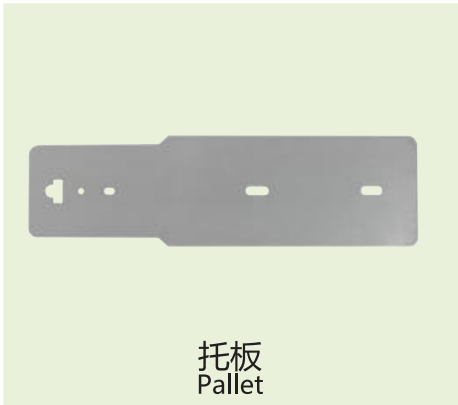

托板  
Pallet



压脚组件  
Pressure Foot Component



风管组件  
Air duct assembly



电磁阀组件  
Electromagnetic valve assembly



控制器  
Controller



传感器支架  
Sensing bracket



调压阀组件  
Pressure valve assembly



吹风集成装置  
Blowing integrated device



气管  
Trachea

**For**

**PEGASUS**

**Series**

# 飞马 W600-AUT/EUT

## PEGASUS W600-AUT/EUT >>>

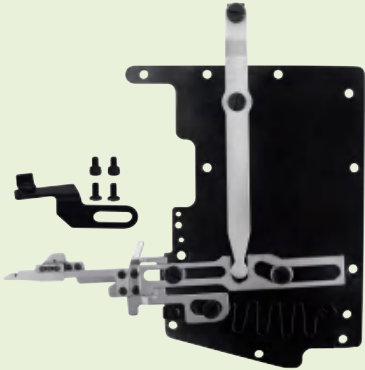

刀盘  
Knife Carrier

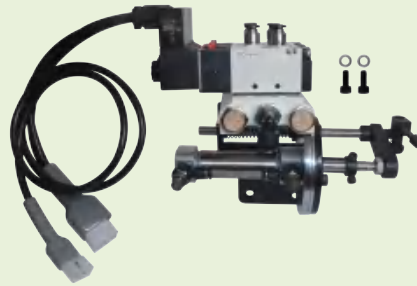

气动下剪线组件  
Air Under Trimmer Drive



气动抬压脚组件  
Air Presser Foot Lifter



松线组件  
Tension Disc Separator



盖 松线传动组件  
Transmission Unit of Tension Disc Separator



调压阀组件  
Pressure valve assembly

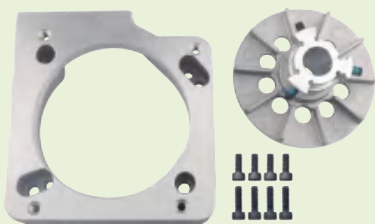

电机座子组件  
Motor seat assembly



下剪线组件  
Under Trimmer Drive



抬压脚组件  
Presser Foot Lifter

# 飞马 W1600-AUT/EUT

## PEGASUS W1600-AUT/EUT

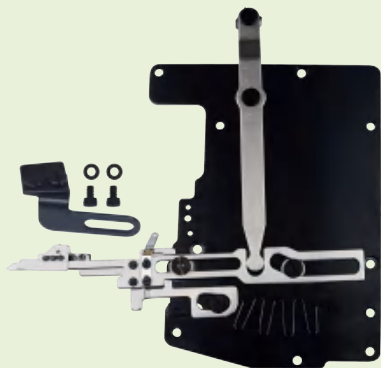

刀盘  
Knife Carrier

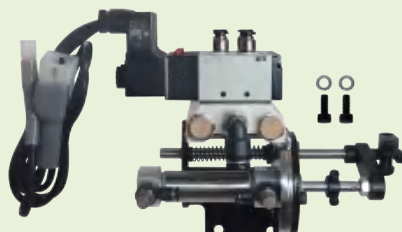

气动下剪线组件  
Air Under Trimmer Drive



气动抬压脚组件  
Air Presser Foot Lifter



松线组件  
Tension Disc Separator

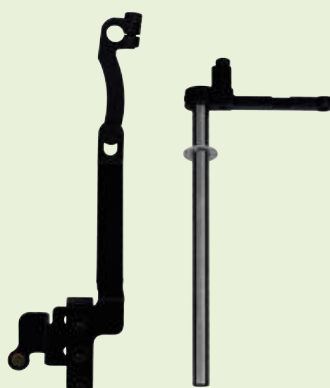

松线传动组件  
Transmission Unit of Tension Disc Separator



调压阀组件  
Pressure valve assembly

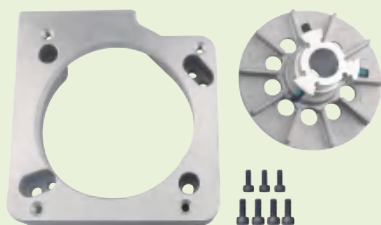

电机座子组件  
Motor seat assembly



下剪线组件  
Under Trimmer Drive



抬压脚组件  
Presser Foot Lifter

# 飞马 W3600-AUT/EUT

## PEGASUS W3600-AUT/EUT >>>



刀盘  
Knife Carrier

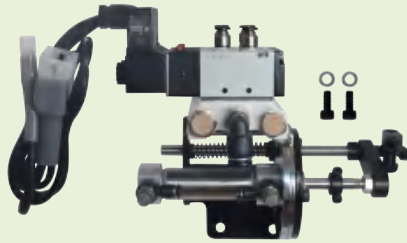

气动下剪线组件  
Air Under Trimmer Drive



气动抬压脚组件  
Air Presser Foot Lifter



松线组件  
Tension Disc Separator



松线传动组件  
Transmission Unit of Tension Disc Separator



调压阀组件  
Pressure valve assembly

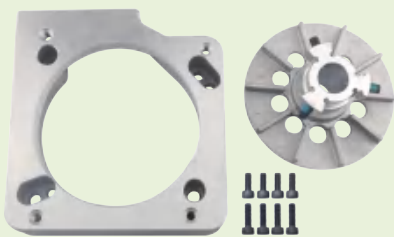

电机座子组件  
Motor seat assembly



下剪线组件  
Under Trimmer Drive



抬压脚组件  
Presser Foot Lifter

# 飞马 W264-AUT/EUT

## PEGASUS C007K-AUT/EUT

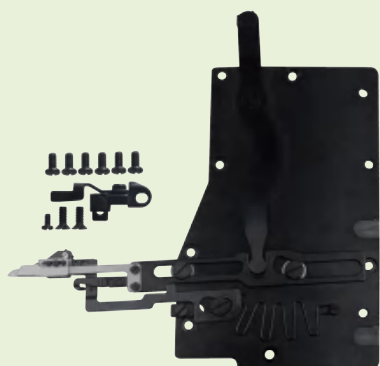

刀盘  
Knife Carrier

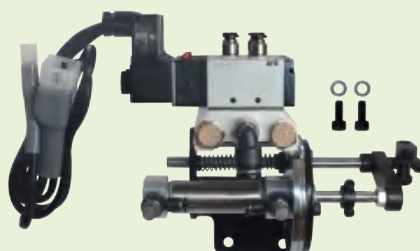

气动下剪线组件  
Air Under Trimmer Drive



气动抬压脚组件  
Air Presser Foot Lifter



松线组件  
Tension Disc Separator

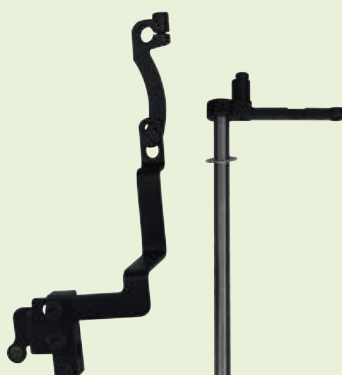

松线传动组件  
Transmission Unit of Tension Disc Separator



调压阀组件  
Pressure valve assembly

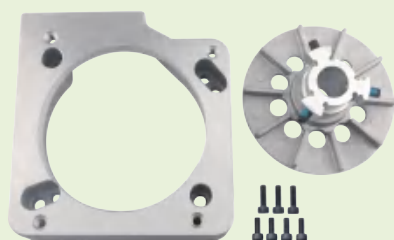

电机座子组件  
Motor seat assembly



下剪线组件  
Under Trimmer Drive



抬压脚组件  
Presser Foot Lifter

# 飞马 W500-AUT/EUT PEGASUS W500-AUT/EUT

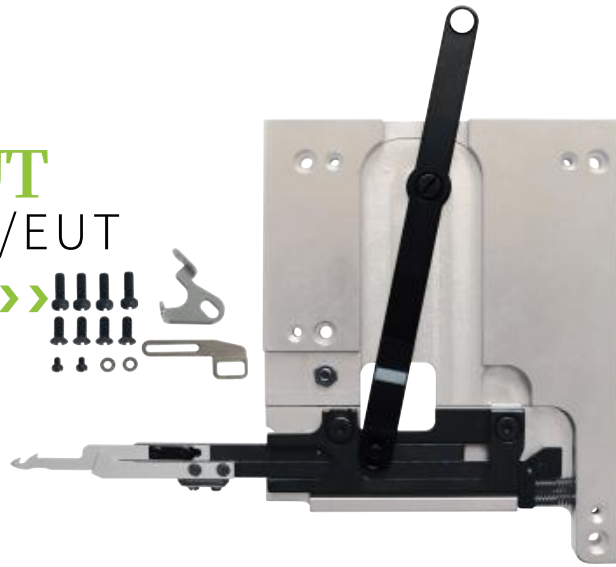

盖板  
Cover

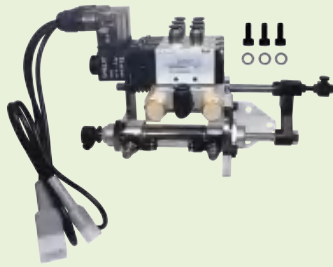

气动下剪线组件  
Air Under Trimmer Drive



气动抬压脚组件  
Air Presser Foot Lifter



松线组件  
Tension Disc Separator



松线传动组件  
Transmission Unit of Tension Disc Separator



调压阀组件  
Pressure valve assembly

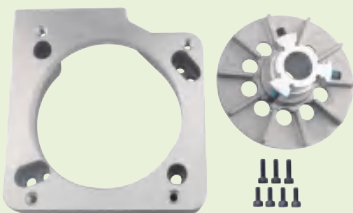

电机座子组件  
Motor seat assembly



下剪线组件  
Under Trimmer Drive



抬压脚组件  
Presser Foot Lifter



# 飞马 FS701P四针六线

## PEGASUS FS701P FLATSEAMER >>>



吸布屑管  
Dust suction tube

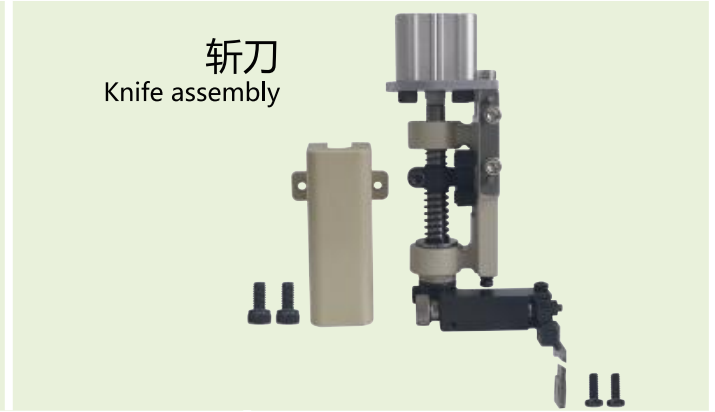

斩刀  
Knife assembly



吸线头管  
Suction tube



电磁阀组件  
Electromagnetic valve assembly



抬压脚组件  
Presser Foot Lifter



控制器  
Controller



手控开关  
Manual switch



光电传感器  
Photoelectric sensor



盖板  
Panel Cover



吹风集成装置  
Blowing integrated device



调压阀组件  
Pressure valve assembly

**For**  
**SIRUBA**  
**Series**

# 银箭C007K-AUT/EUT

## ←←← SIRUBA C007K-AUT/EUT

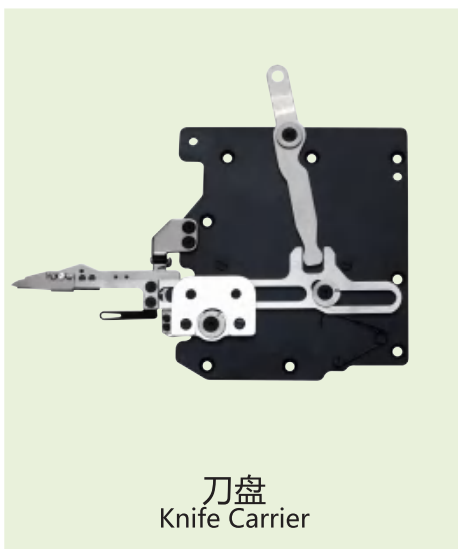

刀盘  
Knife Carrier



气动下剪线组件  
Air Under Trimmer Drive



气动抬压脚组件  
Air Presser Foot Lifter



松线组件  
Tension Disc Separator



松线传动组件  
Transmission Unit of Tension Disc Separator



调压阀组件  
Pressure valve assembly



电机座子组件  
Motor seat assembly



下剪线组件  
Under Trimmer Drive



抬压脚组件  
Presser Foot Lifter



# 银箭S007K-AUT/EUT

## SIRUBA S007K-AUT/EUT >>>



# 银箭F007K-AUT/EUT

## SIRUBA F007K-AUT/EUT

◀◀◀

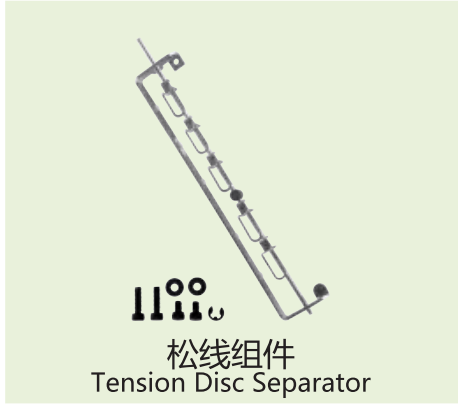
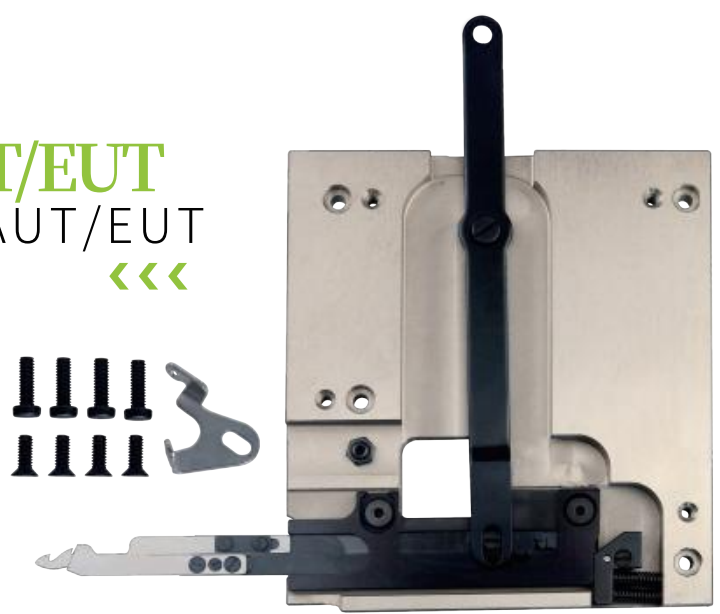

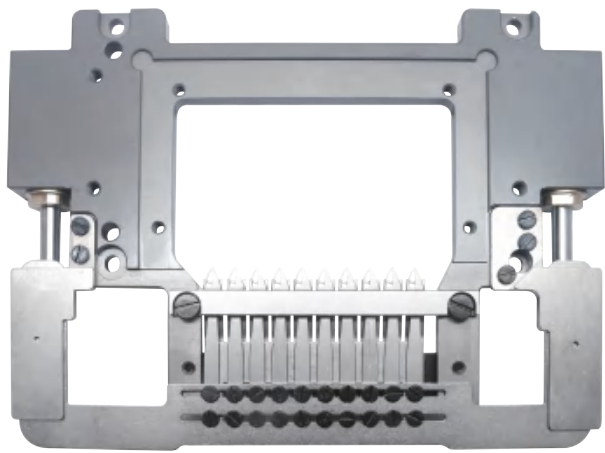

# 银箭VC008多针机

## SIRUBA VC008 Multi-Needle Sewing Machine

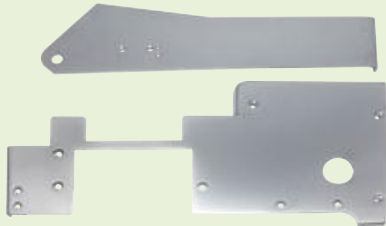

盖板组件  
Cover assembly

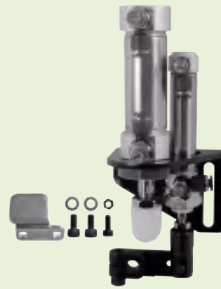

抬压脚组件  
Presser Foot Lifter



底线松线组件  
Bottom loose line assembly



机针线松线组件  
Needle line loose line assembly

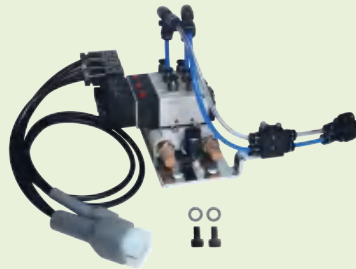

电磁阀组件  
Electromagnetic valve assembly



气动拨线器  
Air Wiper



调压阀组件  
Pressure valve assembly



电机座子组件  
Motor seat assembly



气管  
Trachea

For  
**KANSAS**  
**S P E C T A L**  
Series

# 森本RX9803-AUT/EUT

## KANSAI RX9803-AUT/EUT

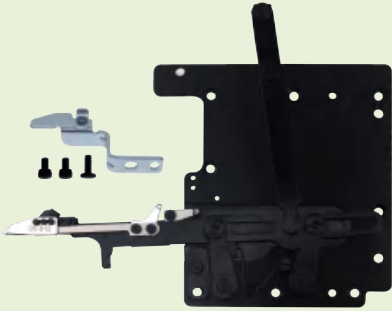

刀盘  
Knife Carrier



气动下剪线组件  
Air Under Trimmer Drive



气动抬压脚组件  
Air Presser Foot Lifter



松线组件  
Tension Disc Separator



松线传动组件  
Transmission Unit of Tension Disc Separator



调压阀组件  
Pressure valve assembly



电机座子组件  
Motor seat assembly



下剪线组件  
Under Trimmer Drive



抬压脚组件  
Presser Foot Lifter



# 森本44系列多针机

## KANSAI 44 Series Multi-Needle Sewing Machine

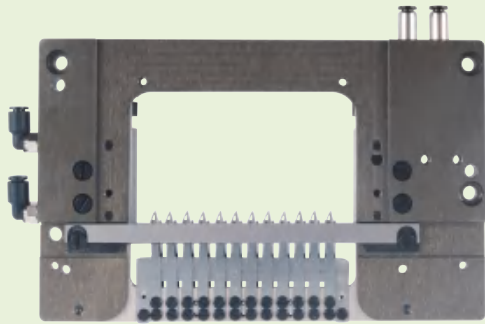

刀盘  
Knife Carrier

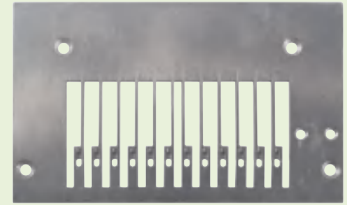

针板  
Pin plate

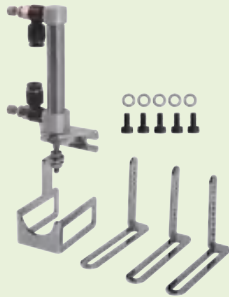

底线松线组件  
Bottom loose line assembly



机针线松线组件  
Needle line loose line assembly



抬压脚组件  
Presser Foot Lifter



松线沙拉组气缸组件  
Line salad group cylinder assembly



电磁阀组件  
Electromagnetic valve assembly



气动拨线器  
Air Wiper



调压阀组件  
Pressure valve assembly

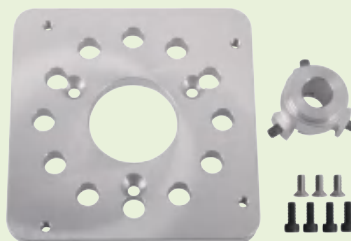

电机座子组件  
Motor seat assembly



气管  
Trachea

**For**  
**SHING RAY**  
Series

# 星锐FW787-AUT/EUT

## SHING RAY FW787-AUT/EUT

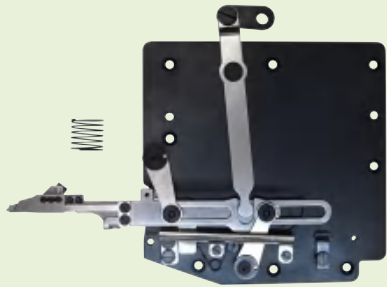

刀盘  
Knife Carrier

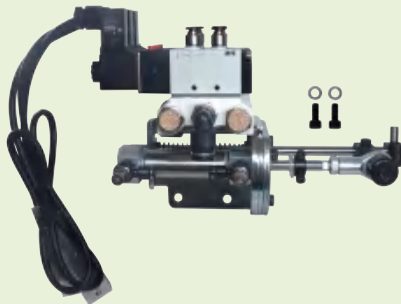

气动下剪线组件  
Air Under Trimmer Drive

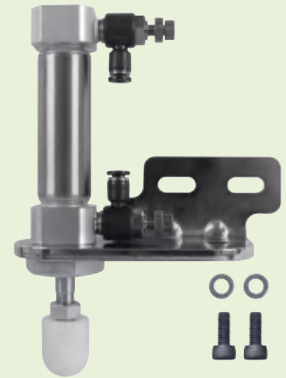

气动抬压脚组件  
Air Presser Foot Lifter

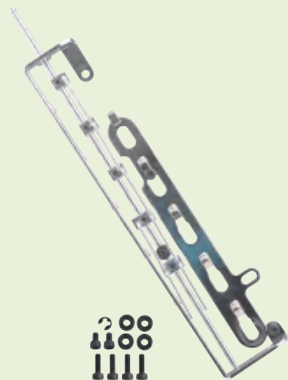

松线组件  
Tension Disc Separator



松线传动组件  
Transmission Unit of Tension Disc Separator



调压阀组件  
Pressure valve assembly

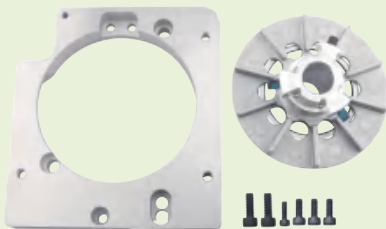

电机座子组件  
Motor seat assembly



下剪线组件  
Under Trimmer Drive



抬压脚组件  
Presser Foot Lifter

# 星锐FW740四针六线

SHING RAY FW740 FLATSEAMER >>>



**For**  
**Kingtex**  
**Series**



# 宝狮 CT9000-AUT/EUT KINGTEX CT9000 FLATSEAMER

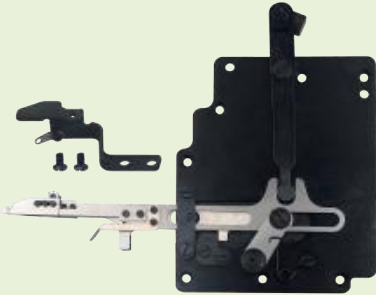

刀盘  
Knife Carrier

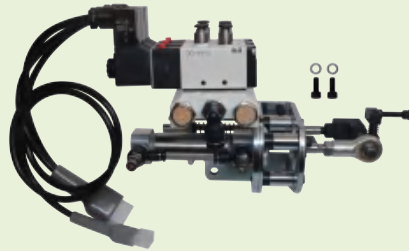

气动下剪线组件  
Air Under Trimmer Drive



气动抬压脚组件  
Air Presser Foot Lifter



松线组件  
Tension Disc Separator



松线传动组件  
Transmission Unit of Tension Disc Separator



调压阀组件  
Pressure valve assembly



电机座子组件  
Motor seat assembly



下剪线组件  
Under Trimmer Drive



抬压脚组件  
Presser Foot Lifter

# 拨线器&上剪刀

Wiper & Top Trimmer

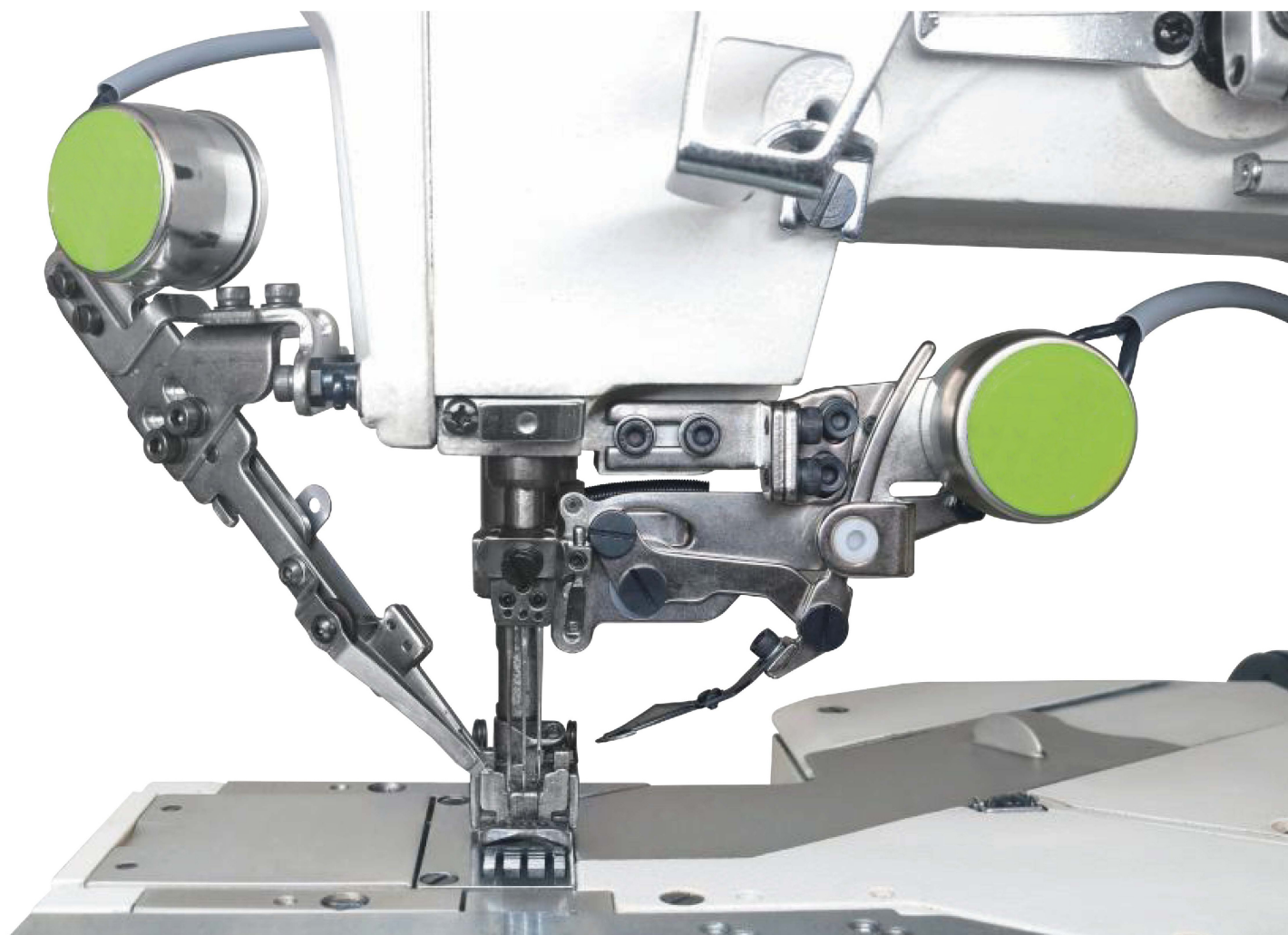

拨线器  
Wiper

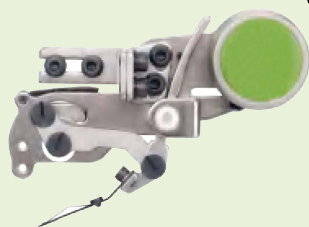

787 气动拨线器  
Air Wiper



气动拨线器  
Air Wiper



上切刀  
Top Trimmer



Y15 上切刀  
Top Trimmer



气动上切刀  
Air Top Trimmer



# 绷缝机型对照表

Interlock Sewing Machine Model Comparison Table

配置 Configuration 型号 Model number	Under bed trimmer device UT	Wiper device WP	New upper trimmer device ST	Motor S(servo) 110V or 220V	用途 USE
UT/WP	√	√	-	√	三针四线, 起缝无线头 3 needles 4 threads, without leaving threads at the beginning of stitches.
UT/ST	√	-	√		三针五线, 自动剪线 3 needles 5 threads, cutting the thread automatically

全机种皆有电动/气动2种形式 All can be used for pneumatic and electric type

\*伺服器可选购 Servo motor can be purchased optionally

品牌 Brand	刀组型号 Knife Model	机型 Model
飞马 PEGASUS	W500	W500
		W3500
		W500PC
	W600	W664
	W1600	W600PC
	W2600	W2600
	W3600	W3622
大和 YAMATO	VC1700	VC1700
		VC1790
		VC2700
	VG2700	VG2700
		VG3721
		VGS2700
	VE2700	VE2700
	VT1500	VES2700
		VT1500
	VF2500	VF2400
VFS2500		
FD-62	FD-62-DRY	
银箭 SIRUBA	C007J	C007J
	C007K	C858K/C007K
	S007K	S007K
	F007J	F007J
	F007K	F858/F007K
日星 SUNSTAR	SC7300	SC7300
青本 QINGBEN	VT1500	QB1500
标准 TYPICAL	VF2500	GK32500
		GK350
		GK335
	VC2700	GK32700
		GK337
		GK370D

品牌 Brand	刀组型号 Knife Model	机型 Model
中捷 ZOJE	ZJ2500	ZJC2500
		ZJC2500-156M-BD-D3B
胜家 SINGER	C007J	SG797-CB356
		SINGER 2542D-356-01
		SINGER 2542K-356-01
杰克 JACK	W664	JK8669 (内置)
	BRUCE 664	JK8669 (外置)
	W264	JK8670
星菱 SHING LING	VG888	VG888
	VG888A	VG888A
	VG888S	VG888S
	VF2500	FG666
FG798		
精机(宝狮) KINGTEX	VC2700	CT6500
	CT9000	CT9000
	CT9713	CT9613
		CT9713
	VF2500	FT6500
FT7000		
星锐 SHING RAY	FW787	FW787
	FW720	FW720
	FW740	FW740
关西(森本) KANSAI SPECIAL	RX9803 (内置)	RX9803 (内置)
	REX9803 (外置)	REX9803 (外置)
	RX1103	RX1103
	KANSAI4412	KANSAI4412
	KANSAI4413	KANSAI4413
重机 JUKI	MF7823	MF7823
	MF7723	MF7723
		MF7523
	MF7923	MF7923
	JUKI 1900A	JUKI 1900A
兄弟 BROTHER	430F	430F